

APPLICATION

Refrigerant	R600a
Application	LBP
Expansion Device	Capillary
Cooling Type	Static
Evaporation temp. range	-35°C to -10°C

Max. Ambient temp.	43 °C
Max. Steady discharge temp.	120 °C
Max. Peak discharge temp.	135 °C
Max. Steady condensing temp.	60 °C
Max. Peak condensing temp.	70 °C
Max. Winding temp.	130 °C

BASIC PARAMETER

Compressor Model	HXL140A
Displacement	8.0 cc
Net Weight	7.3 kg
Oil Type	WF5A
Oil Charge	120 cc
Oil Viscosity @40°C	5 cSt

Power Supply	220~240 V
Voltage Range	187~264 V
Frequency	50 Hz
Motor type	RSCR
Electrical insulation class	B
Height (H)	161 mm

ELECTRICAL DATA

Enamelled Wires Material	Cu
Main Wind. Resistance @20°C	25.43 Ω
Start Wind. Resistance @20°C	47.19 Ω
Locked Rotor Current @220V	6.5 A
Locked Rotor Current after 4s	3.6 A

Connecting board	GD,GDI,GD-3
Run Capacitor	
Type	Plastic or metallic case
Capacitance	2 uf

PERFORMANCE DATA

Cooling Capacity	Input Power	COP	Current
W	W	W/W	A
140	73	1.91	0.37

Evaporating temp.	-23.3 °C
Condensing temp.	+55 °C
Subcooling temp.	+32 °C
Suction temp.	+32 °C
Ambient temp.	+32 °C

Starting test with capacitor	Motor Temp./Equalized Press.	
	90°C/3Bar A	43°C/3.5Bar A
Min. Starting Voltage	172	168

Acoustic test	A-weight SWL	Vibration
	dBA	m/s ²
-20°C/+50°C	38	0.4

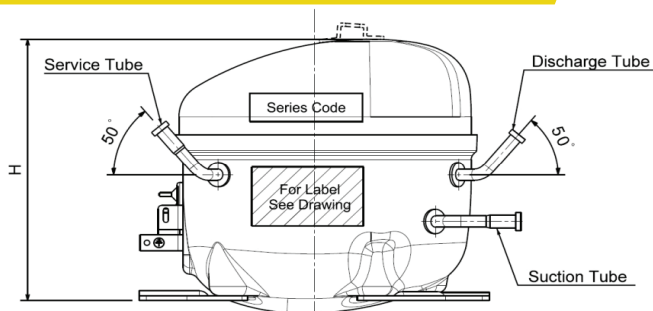
COMPRESSOR OUTLINE

* H is shown in basic parameter.

